

ECE TYPE-APPROVAL CERTIFICATE



Communication concerning:²

Approval granted
~~Approval extended~~
~~Approval refused~~
~~Approval withdrawn~~
~~Production definitely discontinued~~

of a type of direction indicator pursuant to Regulation No. 6

Approval No: **E24*6R01/27*0288*00**

Reason(s) for extension:

N/A

1. Trade name or mark of the device:



2. Manufacturer's name for the type of device:

ZK-01-009

Variants :

**Variant 1: ZK-01-009;
Variant 2: ZK-01-008**

3. Manufacturer's name and address:

**Changzhou Zhongkai Vehicle Parts Co.,
Ltd.
Menghe Avenue, Henghe Town, Xinbei
District, Changzhou City, Jiangsu Province
P.C.: 213001**

4. If applicable, name and address of manufacturer's representative:

N/A

5. Submitted for approval on:

10.01.2018

6. Technical service responsible for conducting approval tests:

**TÜV SÜD Auto Service GmbH
Westendstraße 199
D-80686 München
Germany**

7. Date of test report issued by that service:

04.01.2018

8. Number of report issued by that service:

17-01932-CX-SHA-00

Approval No: E24*6R01/27*0288*00

9. Concise description

Category: 4, 4a, 4b, 2a, 2b, 5, 6²

Rear direction indicator lamp, 2a

Number, category:

One PY21W, filament lamp type

Function(s) produced by an interdependent lamp forming part of an interdependent lamps system:

N/A

Voltage and Wattage:

24 V, 21 W

Light source module specific identification code:

N/A

Only for limited mounting height of equal to or less than 750 mm above the ground: ~~yes~~/no²

No

Geometrical conditions of installation and relating variations, if any:

See manufacturer's information document

Application of an electronic light source control gear/variable intensity control:

N/A

(a) being part of the lamp: ~~yes~~/no²

N/A

(b) being not part of the lamp: ~~yes~~/no²

N/A

Input voltage(s) supplied by an electronic light source control gear/variable intensity control:

N/A

Electronic light source control gear/variable intensity control manufacturer and identification number (when the light source control gear is part of the lamp but is not included into the lamp body):

N/A

Variable luminous intensity: ~~yes~~/no²

No

Sequential activation of light sources (see paragraph 5.6. of this Regulation): ~~yes~~/no²

No

Approval No: E24*6R01/27*0288*00

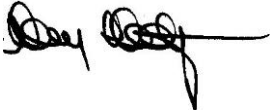
10. Position of the approval mark: *On the lens*
11. Reason(s) for extension (if applicable): *N/A*
12. Approval granted/extended/refused/withdrawn:² *Granted*
13. Place: *Dublin*
14. Date: *26th January, 2018*
15. Signature: 



16. The list of documents deposited with the Administrative Service which has granted approval, is annexed and may be obtained on request.

Index to the Information Package

Date of issue:	<i>26th January, 2018</i>
Date of latest amendment:	<i>N/A</i>
Reason for extension/revision:	<i>N/A</i>
1. Additional conditions, and advisory notes on legal alternatives.	
2. Test report(s)	
- numbers(s):	<i>17-01932-CX-SHA-00</i>
- date of issue:	<i>04.01.2018</i>
- date of latest amendment:	<i>N/A</i>
3. Information document	
- number(s):	<i>ZK-01-009-00</i>
- date of issue:	<i>14.12.2017</i>
- date of latest amendment:	<i>N/A</i>
Documentation:	<i>11 pages</i>



Approval No: E24*6R01/27*0288*00

Appendix: **Additional conditions, and advisory notes on legal alternatives.**

A: Additional conditions:

1. The device, Type ZK-01-009, shall be marked as prescribed in the regulation.
2. The attached technical report, with any of its attachments, forms part of this Type Approval certificate.
3. Each individual product from series production shall be to the measurements specified in the attached drawings, and shall be manufactured only from the materials specified in the Approval documents.
4. Changes in the product are permitted only with the explicit permission of NSAI. Breaches of this requirement will lead to a withdrawal of the Type Approval, and in addition may be subject to criminal prosecution.
5. This Type Approval will expire when it is surrendered by the holder, or withdrawn by NSAI, or when the approved type of product no longer conforms to legal requirements. The recall of the Type Approval can be issued by NSAI when the conditions required for the issuing or continuation of the Type Approval are no longer current, or when the Approval holder is in breach of the duties attached to the Type Approval, or when it is established that the approved type no longer meets the requirements of traffic safety.
6. NSAI may at any time check the correct performance of the duties imposed by the grant of this Type Approval, and in order to do so, may make tests, or have tests made.
7. Changes in the company name, address or manufacturing site, as well as in any of the sales or other agents specified in the issuing of the approval must immediately be notified to the NSAI.
8. The duties imposed by the issuing of this certificate are not transferable. The legal protection of third parties is not affected by this certificate.
9. When the manufacture or sale of the vehicle, system, component or separate technical unit has not been started within one year of the date of issue of this certificate, then NSAI is to be informed. This requirement also applies when the manufacture or sale has been halted for more than one year, or when it ought to have been halted for more than one year. The initial commencement of manufacture or sale, or the resumption of manufacture or sale, shall then be notified to NSAI within one month of commencement or resumption.

B : Legal Options

Any objection to the requirements set out in this certificate shall be made within one month of the date of issue. The objection shall be made, in writing, to NSAI in Dublin.



Technical Report No.: 17-01932-CX-SHA-00
Manufacturer: Changzhou Zhongkai Vehicle Parts Co., Ltd.
Type: ZK-01-009

TECHNICAL REPORT

No.: 17-01932-CX-SHA-00

Test according to ECE regulation relating to

Rear direction indicator lamp category 2a

ECE Regulation No.: 6

supplement 27 to the 01 series of amendments

Approvals granted up to now		
ECE	Number of approval	Date
	---	---

Technical Report No.: 17-01932-CX-SHA-00
Manufacturer: Changzhou Zhongkai Vehicle Parts Co., Ltd.
Type: ZK-01-009

Page 2 / 6

I. Technical description

- 0.1. Make (trade name of manufacturer) : 
- 0.2. Type : ZK-01-009
- 0.2.1. Variants : Variant 1: ZK-01-009;
Variant 2: ZK-01-008
- 0.3. Means of identification of type : By digits and letters
- 0.4. Concise description
- Category : Rear direction indicator lamp category 2a
- Number, category : 1*P21W
- Function(s) produced by an interdependent lamp forming part of an interdependent lamps system : N/A
- Voltage and wattage : 24V and 21W
- Light source module specific identification code : N/A
- Only for limited mounting height of equal to or less than 750 mm above the ground : No
- Geometrical conditions of installation and relating variations, if any : See manufacturer's information document
- Application of an electronic light source control gear/variable intensity control : N/A
- Being part of the lamp : N/A
- Being not part of the lamp : N/A
- Input voltage(s) supplied by an electronic light source control gear/variable intensity control : N/A

Technical Report No.: 17-01932-CX-SHA-00
Manufacturer: Changzhou Zhongkai Vehicle Parts Co., Ltd.
Type: ZK-01-009

Page 3 / 6

Electronic light source control gear/
variable intensity control manufacturer
and identification number : N/A

Variable luminous intensity : No

Sequential activation of light sources
(see paragraph 5.6.) of this Regulation) : No

0.5. Name and address of manufacturer : Changzhou Zhongkai Vehicle Parts Co.,
Ltd.
Menghe Avenue, Henghe Town, Xinbei
District, Changzhou City, Jiangsu Province
P.C.: 213001

0.8. Address of assembly plant : See 0.5

0.9. Location of the approval mark : On the lens

0.10. If applicable, name and address of the
manufacturer's representative : N/A

II. **Test record**

1. Test conditions

1.1. Technical data of the test samples : Two samples were tested.
Sample No. 1, left side mounting.
Sample No. 2, right side mounting.
For information about the form of the
lamp, the position of the reference point
and the reference axis, see information
document.

1.2. Test procedures used : According to ECE Regulation No.: 6.01.

1.3. Measuring and test equipment : Full automatic photometric test system for
automobile lamps
EVERFINE PHOTO-E-INFO CO.,LTD
Type GO-HD5

2. Test results

2.1. General Specifications

The devices have been designed and constructed that in normal conditions of use, and notwithstanding the vibrations to which they may be subjected in such use, their satisfactory operation remains assured and they retain the characteristics prescribed by this Regulation.

No light source module or light generator is used.

2.2. Intensity of light emitted

2.2.1. Sample No. 1 and No. 2, test voltage 13.879V.

No.	Point of the measurement		Limits [cd]		Measured values [cd]		Conclusion
			Min.	Max.	Sample No. 1	Sample No. 2	
1	5L	10U	10.00	500.00	37.94	35.94	Complies
2	5R	10U	10.00	500.00	32.92	43.01	Complies
3	20R	5U	5.00	500.00	21.79	25.00	Complies
4	10R	5U	10.00	500.00	38.65	112.15	Complies
5	H	5U	35.00	500.00	156.61	169.45	Complies
6	10L	5U	10.00	500.00	100.64	42.44	Complies
7	20L	5U	5.00	500.00	21.54	22.28	Complies
8	10L	V	17.50	500.00	144.73	44.66	Complies
9	5L	V	45.00	500.00	354.05	170.03	Complies
10	H	V	50.00	500.00	362.03	375.91	Complies
11	5R	V	45.00	500.00	159.16	365.71	Complies
12	10R	V	17.50	500.00	40.43	138.85	Complies
13	20R	5D	5.00	500.00	23.86	24.71	Complies
14	10R	5D	10.00	500.00	42.84	140.24	Complies
15	H	5D	35.00	500.00	323.67	343.12	Complies
16	10L	5D	10.00	500.00	144.97	52.25	Complies
17	20L	5D	5.00	500.00	26.04	21.96	Complies
18	5L	10D	10.00	500.00	245.83	153.63	Complies
19	5R	10D	10.00	500.00	143.65	260.53	Complies
20	All directions Min.		0.30	---	5.28	6.98	Complies
21	All directions Max.		---	500.00	368.43	380.37	Complies

Technical Report No.: 17-01932-CX-SHA-00
 Manufacturer: Changzhou Zhongkai Vehicle Parts Co., Ltd.
 Type: ZK-01-009

2.3. Colour - Amber

Sample	Measured values		Limits		
	x	y	$y \leq x - 0.120$	$y \geq 0.390$	$y \geq 0.790 - 0.670 x$
No. 1	0.5783	0.4127	Yes	Yes	Yes
No. 2	0.5788	0.4130	Yes	Yes	Yes

2.4. Apparent surface

Limit (I)	Limit (O)	Limit (U)	Limit (D)
52mm	52mm	51mm	51mm

3. Specimen submitted to test on : 2017-12-14 (YYYY-MM-DD)
4. Place of test : Jiangsu Huachen Vehicle Inspection Co., Ltd., Zhenjiang City, P.R. China
- Date of test : 2017-12-19 (YYYY-MM-DD)

III. **Enclosures**

- Manufacturer's information document : ZK-01-009-00
 No.
- Dated on : 2017-12-14 (YYYY-MM-DD)

IV. Statement of conformity

The information folder as mentioned under No. III and the type described therein are in compliance with the test specification mentioned above. The worst-case was selected in accordance with document “Preparation of Test Reports”.

The test report may be reproduced and published in full and by the client only. It can be reproduced partially with the written permission of the test laboratory only.

München, 2018-01-04
 (YYYY-MM-DD)



Joe Zhou

Test Laboratory / DIN EN ISO 17025

Genehmigungsbehörde/ Approval authority	Land/Country	Registriernummer/ Registration-number	Aktueller Benennungsumfang/ Actual scope list
Kraftfahrt-Bundesamt (KBA)	Deutschland/ Germany	KBA-P 00100-10	www.kba.de
Vehicle Certification Agency (VCA)	Vereintes Königreich/ United Kingdom	VCA-TS-006	http://ec.europa.eu/enterprise/sectors/automotive/approval-authorities-technical-services/technical-services/index_en.htm
Approval Authority of the Netherlands (RDW)	Niederlande/ The Netherlands	RDWT-082-XX	
National Standards Au- thority of Ireland (NSAI)	Irland/ Ireland	Technical Service Number: 49	http://www.vsc.org.tw/English/Default.aspx
Vehicle Safety Certifica- tion Center (VSCC)	Taiwan/ Taiwan	DE04-06-2	

Information folder No. : ZK-01-009-00

First application date : December 14, 2017

1. Specification data

Type		ZK-01-009									
Variant		Variant 1: ZK-01-009 Variant 2: ZK-01-008									
Function		Rear group lamp									
		Rear retro-reflector Device	Side retro-reflector Device	License plate lamp	Rear direction indicator lamp	Stop lamp	Rear position lamp	Rear end -outline marker lamp	Reversing lamp	Rear fog lamp	Side marker lamp
Color		Red	Amber	Colorless	Amber	Red	Red	Red	White	Red	Amber
Rated	Voltage	--	--	24V	24V	24V	24V	24V	24V	24V	24V
	Wattage	--	--	10W	21W	21W	2*10W	10W	21W	21W	10W
Application Regulation ECE		R3.02 Class IB	R3.02 Class IB	R4.00 Cat. 1b	R6.01 Cat. 2a	R7.02 Cat. S1	R7.02 Cat. R1	R7.02 Cat. RM1	R23.00 AR	R38.00 Cat. F1	R91.00 Cat. SM1
Location of marking	Number and category of light source	--	--	R10W	P21W	P21W	2*R10W	R10W	P21W	P21W	R10W
	Trade mark	Marked on housing									
											
	Approval mark	Marked on lens									
Remark		Sequential activation of light sources: No									
		The lamp is only for use on a vehicle fitted with a tell-tale indicating failure: No									

2. Construction and material

Construction	Material	Remarks
Lens	AS	L.P.L.+R.L.: Clear S.D.+R.D.L.+S.M.L.: Amber R.D.+S.L.+R.P.L.+R.E.L.+R.F.L.: Red
Reflector	PP	AL vacuum vapour coating Painting on the inside surface Colour: Metal silver
Housing	ABS	Colour: Black
Electrical Wiring	Copper covered with insulation	--

3. Name and address of manufacturer

Changzhou Zhongkai Vehicle Parts Co., Ltd.
: Menghe Avenue, Henghe Town, Xinbei District,
Changzhou City, Jiangsu Province P.C.: 213001

4. Name and address of the assembly plant

: See 3.

5. Name and address of the manufacturer's representative

: N/A

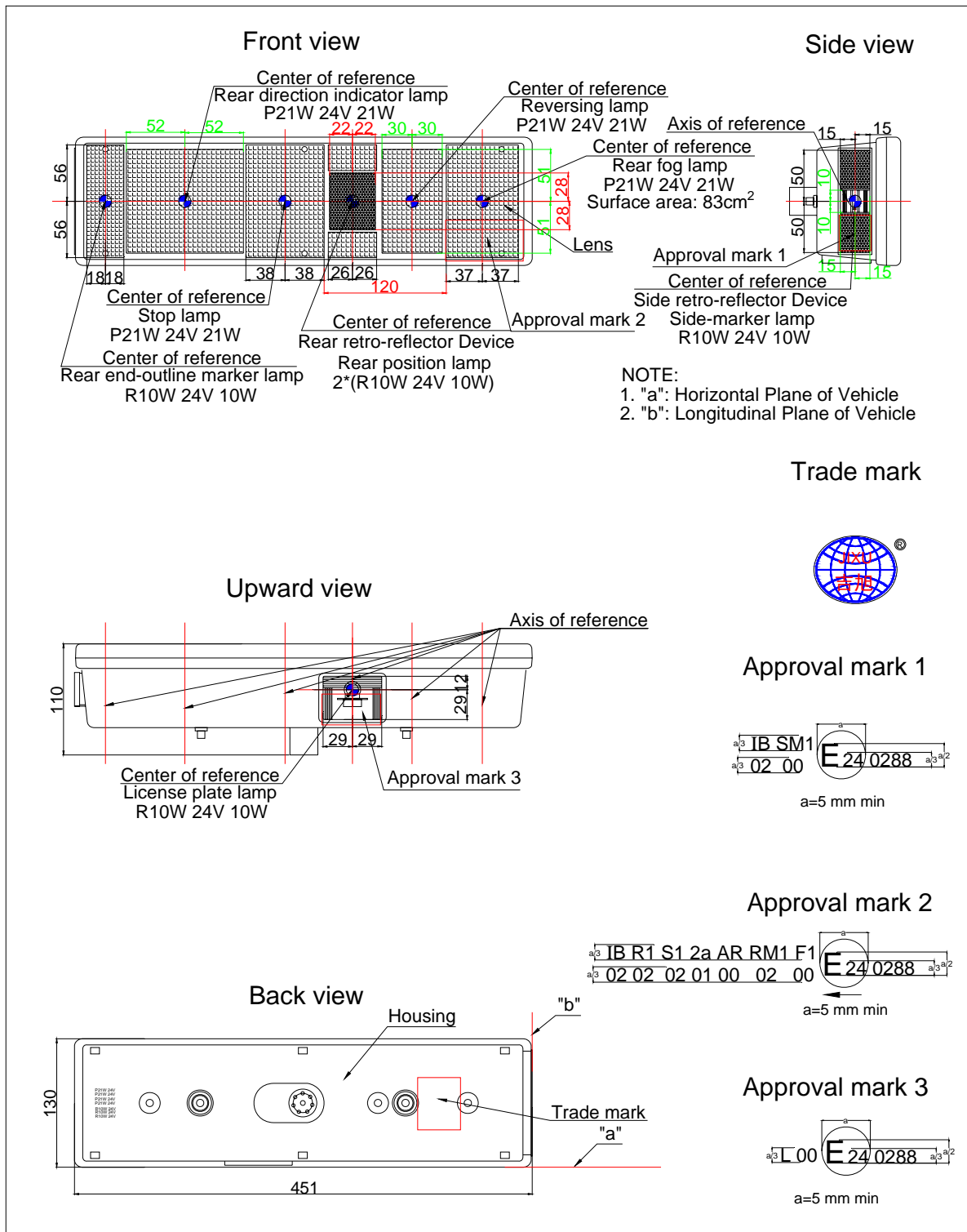

Product Type	ZK-01-009
General assembly drawing (Left side)	
Drawing No.	ZK-01-009-01

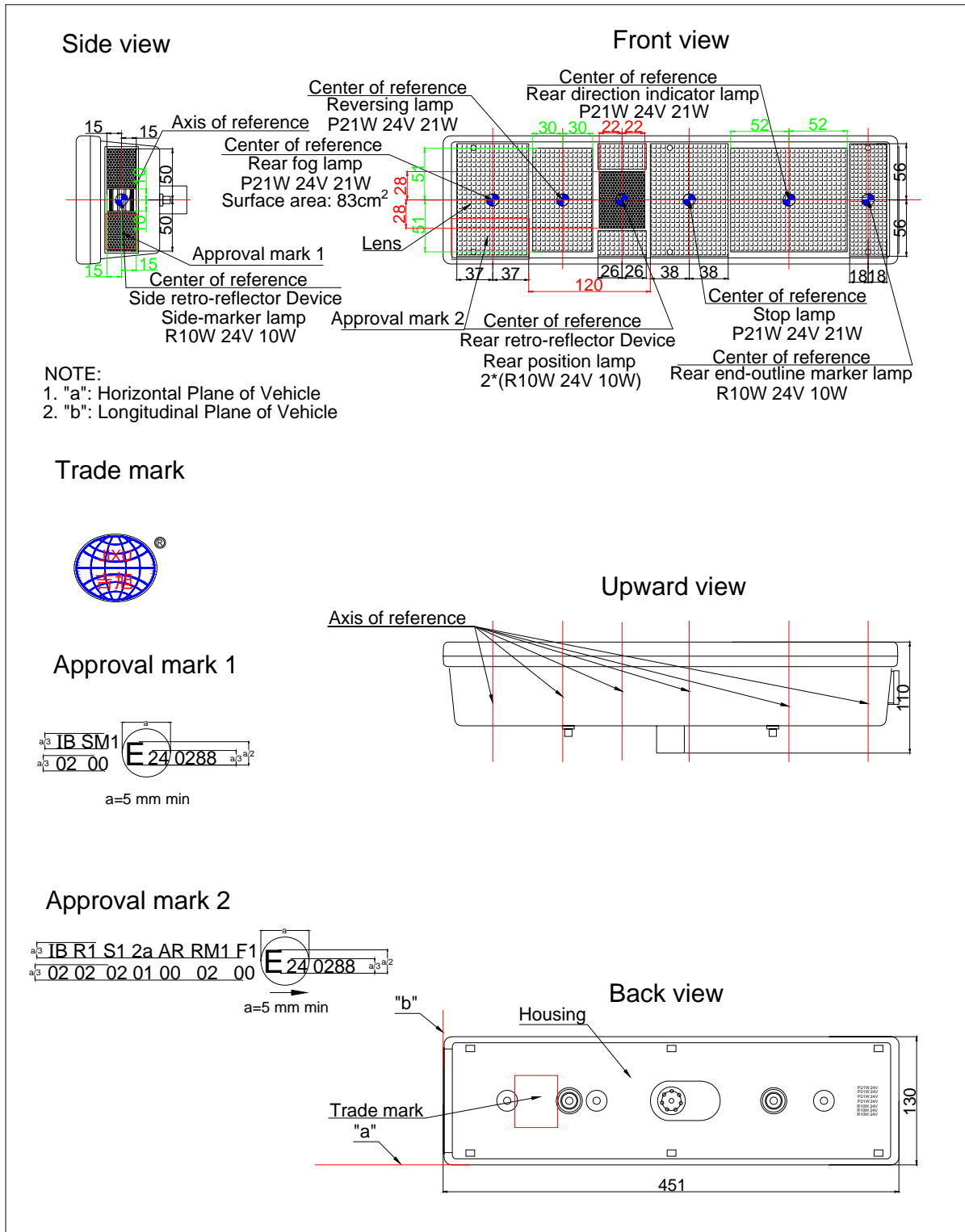

Product Type	ZK-01-009
General assembly drawing (Right side)	
Drawing No.	ZK-01-009-02

Installation requirements of rear license plate

Front view

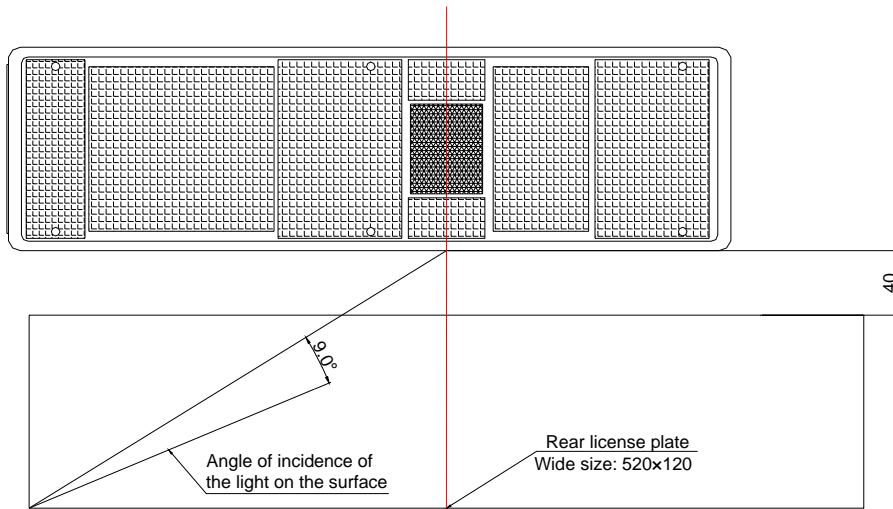

Side view

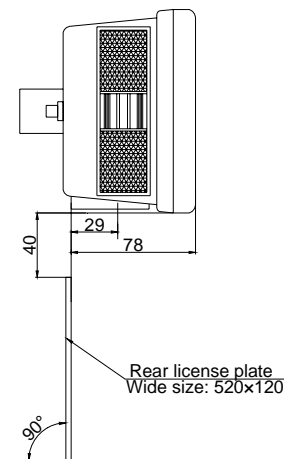

Product Type	ZK-01-009
Installation requirements of rear license plate	
Drawing No.	ZK-01-009-03

Information folder No. : ZK-01-009-00

First application date : December 14, 2017

Back view

Variant 1

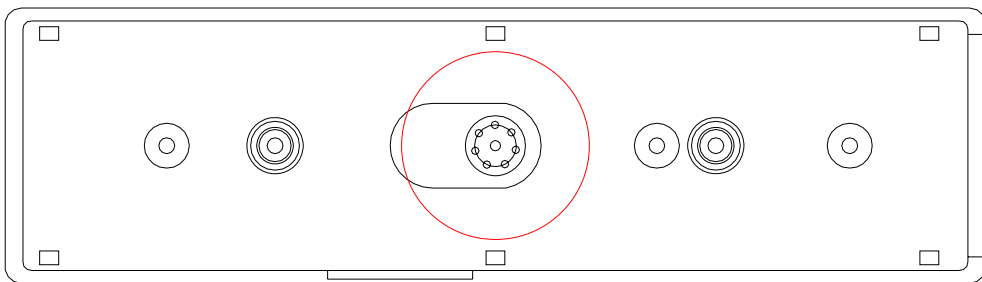

Variant 2

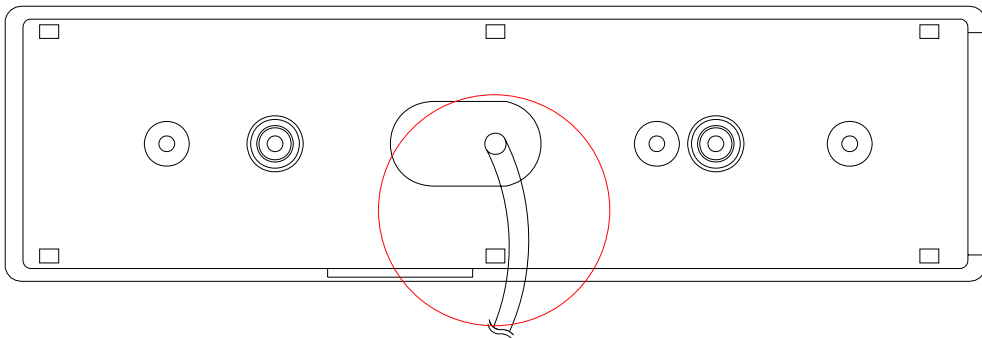

Product Type	ZK-01-009
Variant	
Drawing No.	ZK-01-009-04